

experience

function

quality

style

technology



backrest brochure





Safe-Assist® BACKREST for Healthcare Applications

The BACKREST, a support device for toilets, bidets and the like, introduced into the Australian Standard for Access and Mobility to comply with the changing requirements for sanitary facilities.

The BACKREST provides a support that improves the comfort of using a toilet while simultaneously providing an acceptable level of safety for disabled, aged and infirmed.

Con-Serv® patented BACKREST options as shown are compatible with all cisterns. But due to the different dimensions in cistern design, it is essential to select the correct BACKREST option to comply with the Australian Access and Mobility Standard AS 1428.1-2009 for single (Figure 52 of AS 1428.1-2009) or

combined (Figure 50 of AS 1428.1-2009) sanitary compartments.

Tested by the Australian National Testing Laboratories Pty Ltd (ANTL) as outlined in clause 15.2.4 BACKREST of AS 1428.1-2009, careful selection from the Con-Serv® Safe-Assist® BACKREST range will ensure full compliance with the Australian Standards requirement. Floor mount BACKREST test report – 3104.11 and Wall Mount BACKREST test report – 3411.11

For further information, refer to the BACKREST Suitability Guide or contact our Technical Product Adviser on the Priority Phone Number – 1300 467 322.

Safe-Assist® BACKREST Options



Model - BR 395

PATENT NUMBER 2010100132

Suits all standard accessible suites. Ideally suited to applications when fastening to rear wall is not an option. E.g. vinyl walls or insufficient bracing.



Model - BR 400

PATENT NUMBER 2010101409

Adjusts to suit cisterns from 340 mm to 476 mm width, while still allowing the unimpeded installation and access to other grab rails at side of pan as per requirements of AS 1428.1-2009 (fig 42).



Model - BR 440

PATENT NUMBER 2010101409

Flexible installation left or right side of cisterns from 340 mm to 476 mm width and includes an additional 400 mm grab rail extension as per requirements of AS 1428.1-2009 (fig 42).

SUITABILITY GUIDE	BR 395	BR 400	BR 440
Sanitary Compartment with Conventional Pan	•	•	•
Sanitary Compartment with Wall Faced Pan		•	•
Sanitary Compartment with Shower and Conventional Pan	•	•	
Sanitary Compartment with Shower and Wall Faced Pan		•	



SAFE-ASSIST® - BACKREST

SAFE-ASSIST® BACKREST support for single toilet suites and combined PWD sanitary compartments.

Robust designed 32 mm grade 304 stainless steel Backrest. Fabricated with a choice of 78 mm domed CLAM FLANGE™ or 50 mm HYGIENIC SEAL® healthsafe flange cover. The Backrest features a 97° tamperproof, sanitary safe, Polar White, UV stabilised High Density Polyethylene (HDPE) rounded edge back support.

Complies as per the requirements of AS 1428.1-2009 section 15.2.4-BACKREST.



BR 395 - FLOOR MOUNTED BACKREST

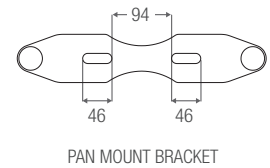
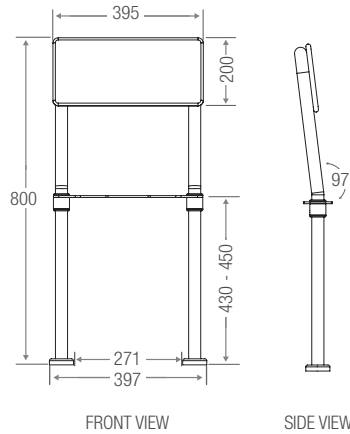
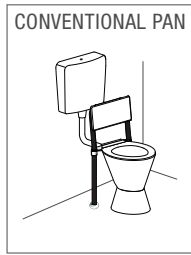
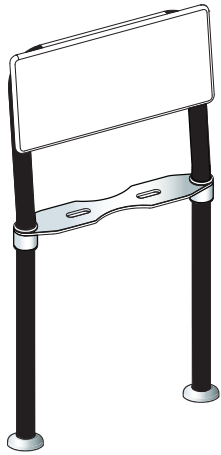

- Suits all standard accessible suites (Not wall faced pans)
- For single PWD cubicle with conventional pan.
- For combined PWD sanitary compartment with conventional pan and shower recess grabrail.
- Fixed to floor with triple screw floor mount and screw on sealed healthsafe flange covers.
- Stainless steel fixing screws supplied.

Patent Number 2010100132

BR 400 - WALL MOUNTED BACKREST

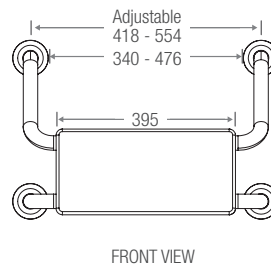
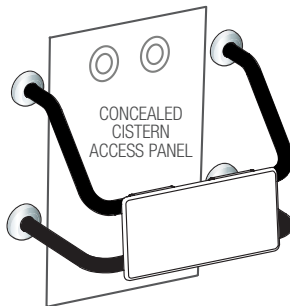

- For single PWD cubicle with conventional pan.
- For single PWD cubicle with wall faced pan.
- For combined PWD sanitary compartment with conventional pan and shower recess grab rail.
- For combined PWD sanitary compartment with wall faced pan and shower recess grab rail.
- Also suitable for concealed cisterns.
- Stainless steel fixing screws supplied.

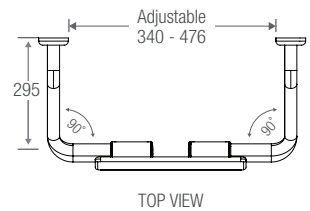
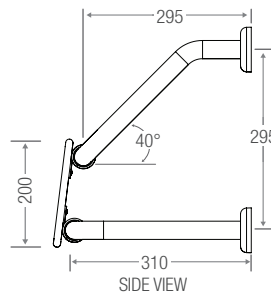
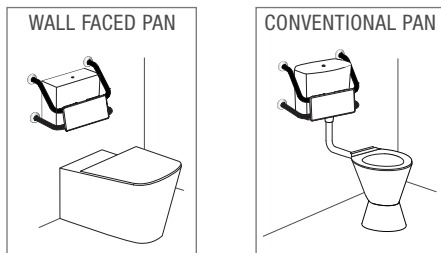

Patent Number 2010101409

BR 440 - WALL MOUNTED BACKREST WITH 400 mm EXTENSION

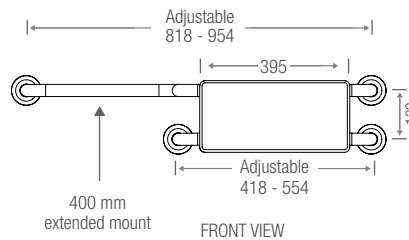
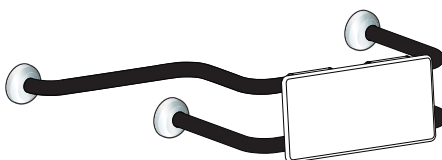

- For single PWD cubicle with conventional pan.
- For single PWD cubicle with wall faced pan.
- For combined PWD sanitary compartment with conventional pan and shower recess grab rail
- The adjustable 400 mm extended mount can be installed on the left or right hand side of cistern.
- Stainless steel fixing screws supplied.

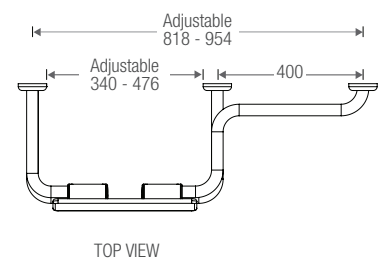
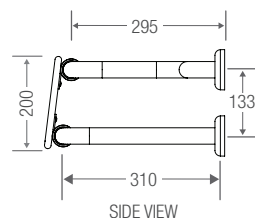
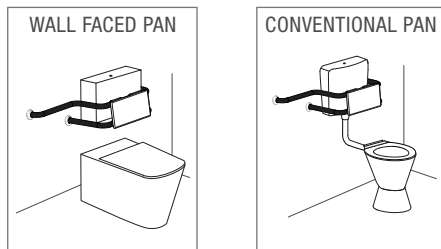

Patent Number 2010101409



Protecting the world's most valuable liquid asset... water!



Our Promise

Con-Serv Corporation Australia Pty Ltd warrants all products to be free from manufacturing defects for 5 years from date of purchase. Con-Serv will repair or replace defective items if defects occur in normal use. Con-Serv will not be liable for defects arising through normal wear and tear. Item(s) must be returned with proof of purchase to Con-Serv at 17 Glentanna Street, Kedron, Queensland 4031. We will attend to your warranty claim after we make appropriate investigations. Contact our Service Manager during normal office hours on 1300 467 322 or at our email address of warranty@con-serv.com.au. If a warranty claim is accepted Con-Serv will bear the reasonable costs of the return of the defective item(s) to us. A claim for expenses associated with making a claim for a defective product must be in writing and submitted to us with copies of supporting documents. The benefits given under our warranty are in addition to other rights and remedies of the customer under a law in relation to goods and services to which this warranty relates. Our goods come with guarantees that cannot be excluded under the Australian Consumer Law. You are entitled to a replacement or a refund for a major failure and compensation for any other reasonable foreseeable loss or damage. You are also entitled to have the goods repaired or replaced if the goods fail to be of acceptable quality and the failure does not amount to a major failure.